

Simplified Optics Integration for Instrument Designers



High-Quality Optical Components for Instrumentation

Olympus is a leading manufacturer and supplier of OEM optical components that easily integrate into advanced devices for life science research, clinical research, industry, and other fields. Our stringent quality control standards help ensure that you are always getting a quality product to integrate into your designs.



Rigorous Quality Control for Consistent Performance



Strong Focus on Quality Assurance

At our production facility in Nagano, Japan, strict tests are completed during every production phase to enable optical performance, safety, and durability. Highly skilled technicians are professionally trained through our skills program and strive for consistent quality.

Evident Nagano Corporation. Site area approx. 126,000 m² (1,356,252 ft²); Floor area approx. 60,000 m² (645,834 ft²)

Precise Optical Manufacturing and Measurement

Olympus technicians measure wavefront aberration during the assembly processes for X Line and some other types of objectives. Wavefront aberration is caused by the deviation of the formed image from the ideal one and is controlled as a quality parameter. By measuring and controlling the wavefront aberration of each objective to bring it closer to its ideal state (aberration-free), we produce objectives with much less variation in optical performance compared to conventional objectives. The result is consistent quality.

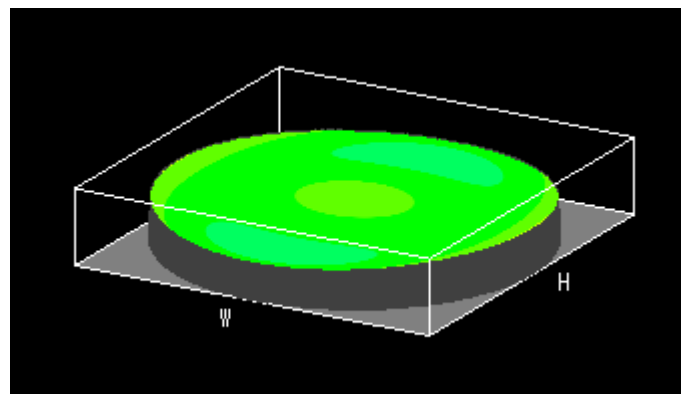
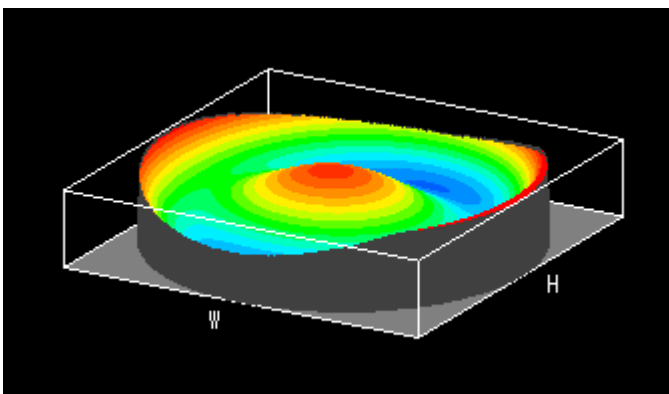

Examples of wavefronts: (left) aberrated wavefront, (right) nearly aberration-free wavefront

Optical Components Designed for Easy Integration

Compact and Lightweight Objectives

Olympus UIS2 objectives are compact and lightweight: every objective has a parfocal distance of 45 mm. Use our Objective Finder to review objective size specifications and export the data sheet as a PDF file for easy reference. The MPLFLN and LMPLFLN series objectives have an aluminum barrel cover, suppressing vibration by lowering the inertia generated when users switch objectives and reducing load when moving up and down. The Objective Finder is located at: www.olympus-lifescience.com/objective-finder/

Working distance and parfocal distance

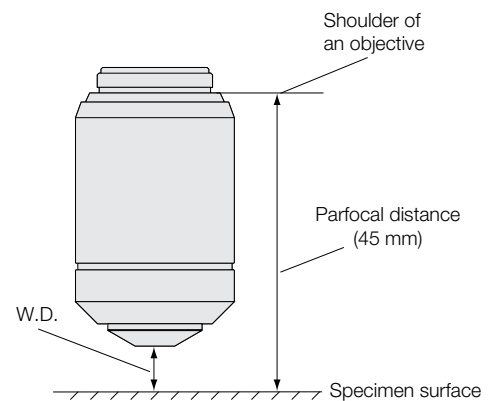

Compensation-Free Optical System

Olympus UIS2 objectives and tube lens units are designed as compensation-free (independently corrected) lenses. As a result, these optical components help you engineer devices that maintain a uniform image quality throughout the field of view—even when used with commercially available lens components.

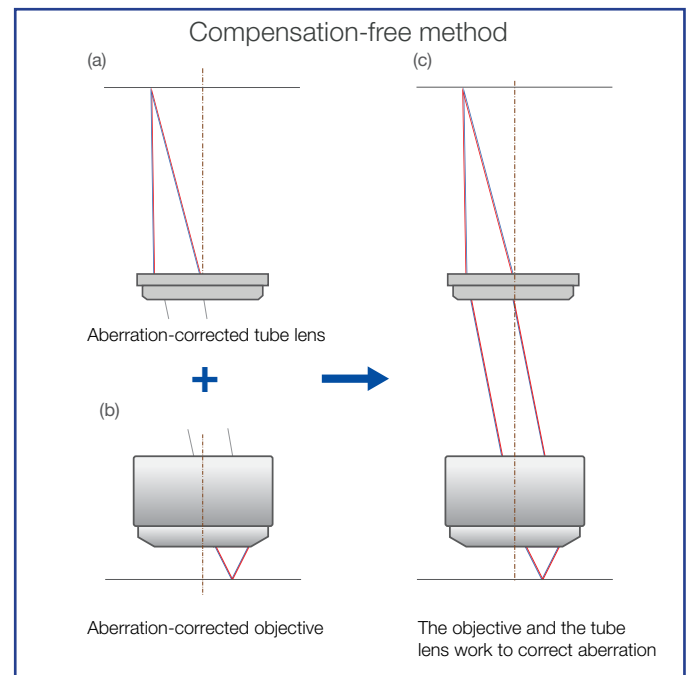
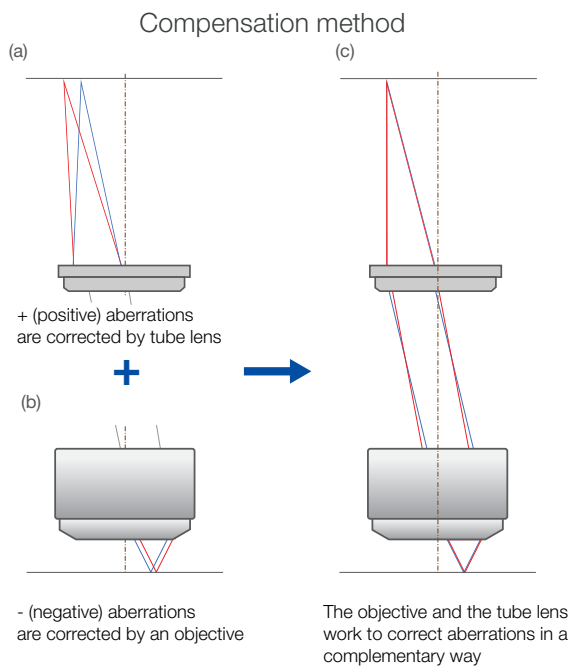

The difference between the compensation method and the compensation-free method.

X Line High-Performance Objectives

X Line objectives deliver improved performance in three critical areas—a larger numerical aperture, better image flatness, and a wider range of chromatic correction.

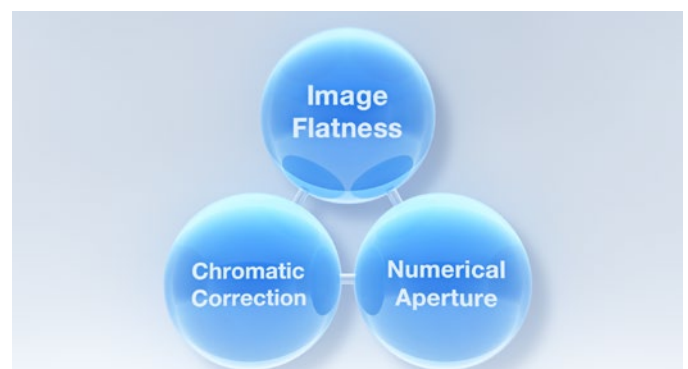
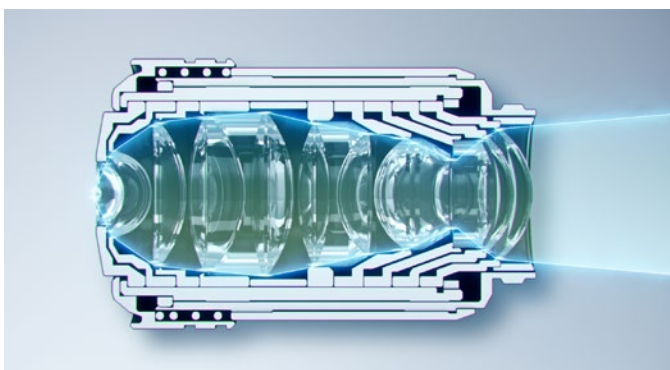

Custom Solutions for Specific Device Needs

Compact Optical Designs

Optical engineers and instrument designers can choose from over 200 objectives, tube lenses, and camera adaptors to design shorter optical systems for compact devices. The illustration below shows an example of how a shorter imaging optical system can be designed with a total length of 217 mm.

It is also important to select an adaptor magnification so that the value obtained by dividing the camera sensor's diagonal by the adaptor's magnification doesn't exceed the image circle of the tube lens. Please verify with the actual device that the field of view and image quality are designed as expected.

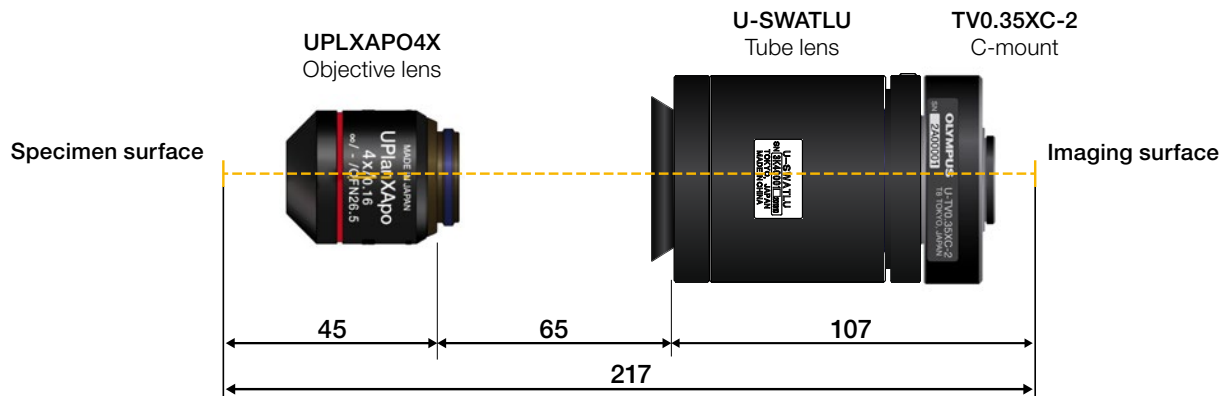

Example of a compact imaging optical system with a total length of 217 mm.

Modular Systems for Easy Configurations

Modular systems give you the flexibility to engineer a device that meets specific project needs and update it as needs change—without a total redesign.

Microscope Component Solutions for Various Applications

Applications	Suggested Products or Configuration
Detailed imaging device	UPLXAPO objectives + SWTLU-C tube lens unit
Compact medical device	UPLFLN objectives + SWTLU-C tube lens unit
Raman microscopy	BX53/BXFM microscopes
Cytology	BX43/CX43 microscopes
Low-cost point-of-care (POC) device	PLN objectives + U-TLU tube lens unit
High-end research microscopy	IX83/BX63 motorized microscopes
In vitro fertilization (IVF)*	IX/BX/CX/SZX/SZ microscopes
Semiconductor inspection tools	BXFM microscope



*For Research Use Only

- EVIDENT CORPORATION is ISO14001 certified.
- EVIDENT CORPORATION is ISO9001 certified.

www.EvidentScientific.com

- All company and product names are registered trademarks and/or trademarks of their respective owners.
- Specifications and appearances are subject to change without any notice or obligation on the part of the manufacturer.